

HAMMELMANN®



THOROUGH CLEANING OF TANKS, VESSELS AND CONTAINERS

AQUAMAT and AQUAREX® tank cleaning systems

For various diameters

For tank openings as little as Ø 4 in.

Minimum pressure loss

Operating pressure up to 26,000 psi

Great reliability

Versatile application



AQUAMAT
TANK CLEANING UNITS

CLEAN TANKS AND CONTAINERS THOROUGHLY AND QUICKLY

Hammelmann tank cleaning units remove deposits and incrustations from the inner and outer walls of tanks and tank installations at operating pressures of up to 26,000 psi. The units operate solely using the recoil force of the water jet. Hammelmann offers a wide range of nozzle holders for various applications. The tank cleaning units can be fitted with one or two nozzle holders.



EXTREMELY POWERFUL

Efficient cleaning performance thanks to high operating pressures (up to 26,000 psi) and high flow rates (up to 185 gpm l/min).



EFFECTIVE AND ENVIRONMENTALLY FRIENDLY

Hammelmann tank cleaning units are developed with performance and sustainability in mind. The high efficiency of the systems makes their use particularly energy-efficient.



GREAT RELIABILITY

Great reliability and long service life thanks to the well thought-out, low-maintenance design and compact housing.



SAFE AND PROTECTED

Wear-resistant, infinitely variable braking system. The adjustment mechanism is protected from dirt and debris.

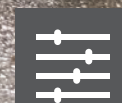

SUITED FOR ANY APPLICATION

Available in different versions, such as explosion-proof, gas-tight encapsulated, pressure-resistant or for chemical media.



FLEXIBLE, ADAPTABLE, COMBINABLE

Various nozzle holders and other accessories and configuration features adapt the device to any challenge.



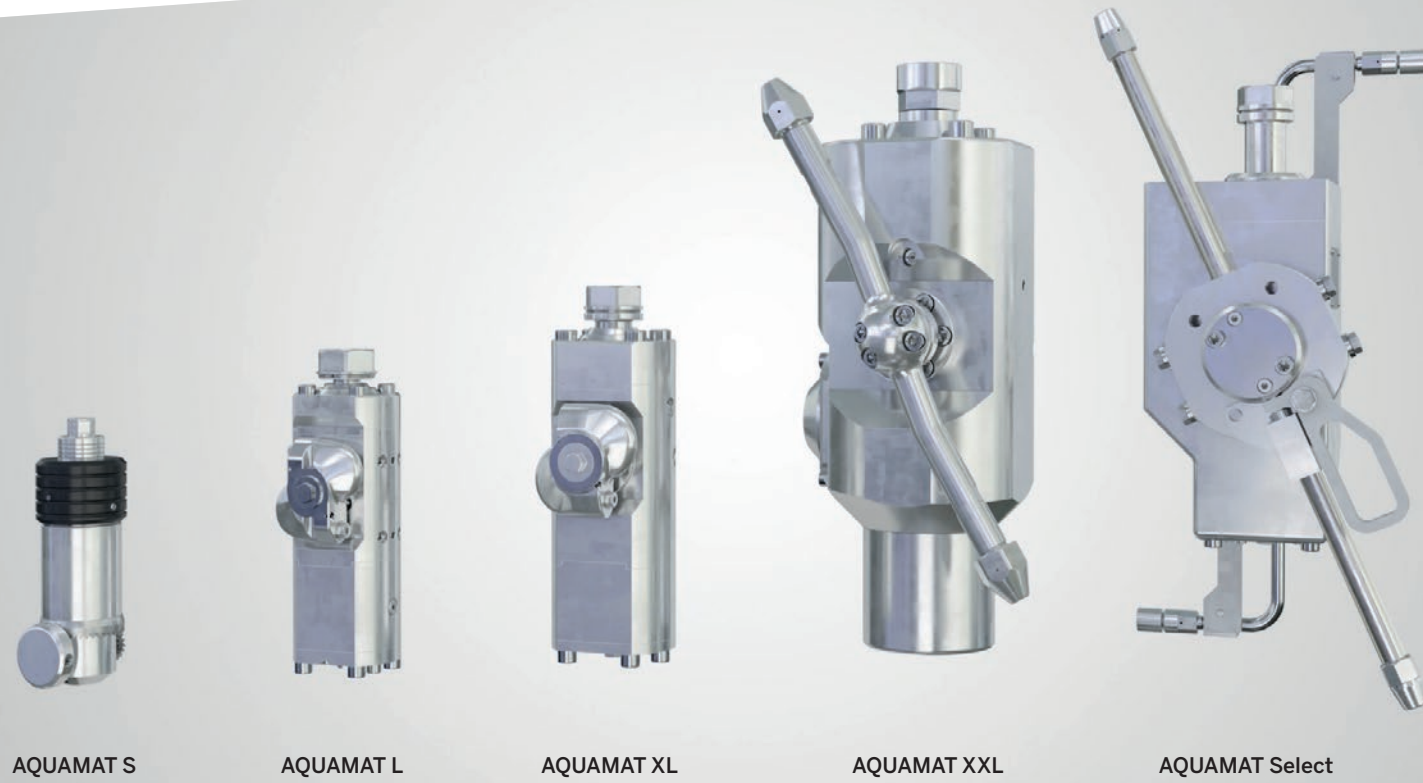

AQUAMAT S 600

Cleaning of an ASF container



AQUAMAT S AQUAMAT L AQUAMAT XL AQUAMAT XXL AQUAMAT Select

OVERVIEW OF AQUAMAT MODELS (MORE MODELS ON REQUEST)

Model	Operating pressure	Flow rate*	Tank opening ▼	Weight
S 600	up to 8,700 psi	up to 26.5 gpm.	Ø 3.9 in.	~ 10.8 lbs
L 500 Plus EX	 up to 7,250 psi	up to 80 gpm.	Ø 5.51 in.	~ 26.0 lbs
L 1500 Plus	up to 21,700 psi	up to 80 gpm.	Ø 5.51 in.	~ 25.3 lbs
L 1500 Plus Titan	up to 21,700 psi	up to 80 gpm.	Ø 5.51 in.	~ 17.9 lbs
L 1800 Plus	up to 26,000 psi	up to 53 gpm.	Ø 7.5 in.	~ 25.3 lbs
XL 1600 Plus	up to 23,200 psi	up to 119 gpm.	Ø 7.5 in.	~ 40.6 lbs
XL 1600	  up to 23,200 psi	up to 66 gpm.	Ø 8.1 in.	~ 84.9 lbs
XXL 1600	  up to 23,200 psi	up to 185 gpm.	Ø 11.8 in.	~ 250.0 lbs
AQUAMAT Select	up to 23,200 psi	up to 132 gpm.	Ø 15.7 in.	~ 158.7 lbs

*Energy-efficient flow rates with low pressure loss. Higher flow rates however are possible.

 Zone 0 / Explosion-proof

 Pumping of chemical media possible

 Pressure-resistant / Gas tight



AQUAMAT L 1500 Plus
With "S"-type nozzle holder



AQUAMAT L 1500 Plus
With "S"-type nozzle holder

CLEANING OF SMALL AND MEDIUM-SIZED CONTAINERS

For small and medium-sized containers, the AQUAMAT tank cleaning unit (TCU) is positioned centrally and set into rotation by the recoil of the water jets. Depending on the container, the AQUAMAT can be moved into different positions.

An ideal ratio of the rotational movements and the adjustable speed ensure an even and complete cleaning result.

The rotation speed is set and kept constant by a maintenance-free eddy current brake.



Simulation:
AQUAMAT S 600
Cleaning of an
IBC-Containers

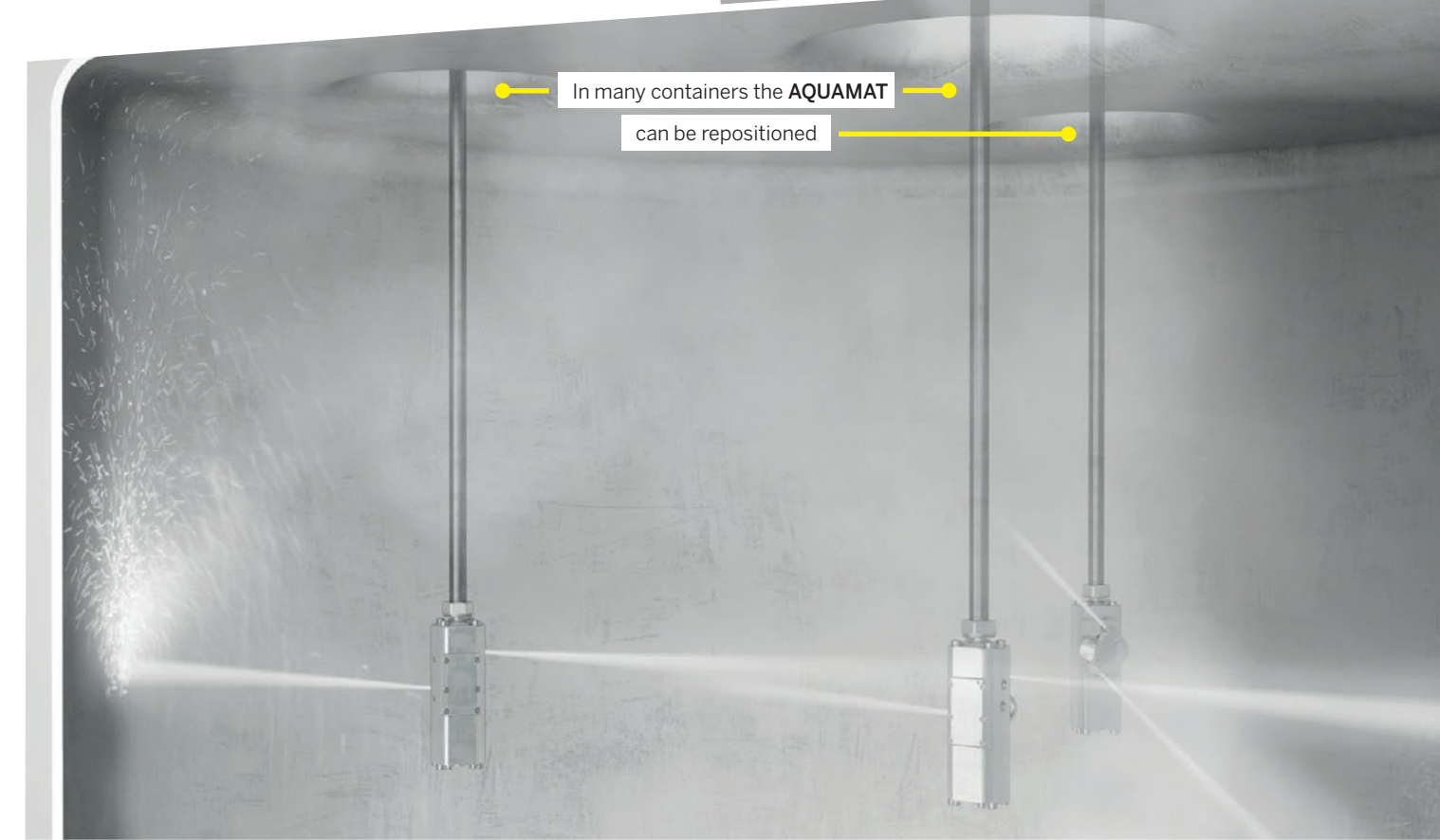

In many containers the **AQUAMAT**
can be repositioned

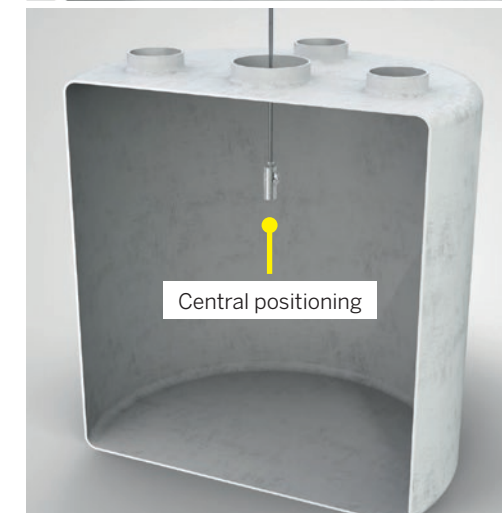

Central positioning

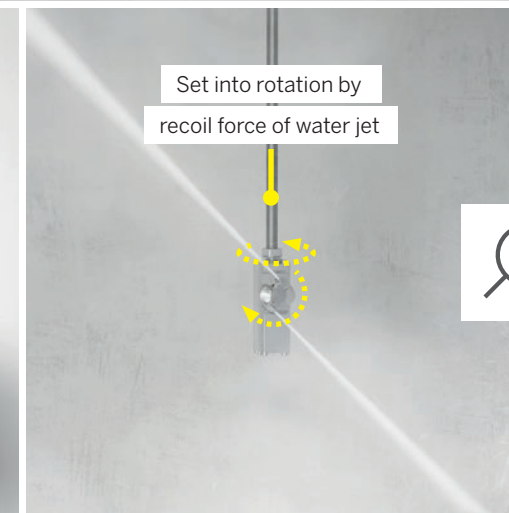

Set into rotation by
recoil force of water jet

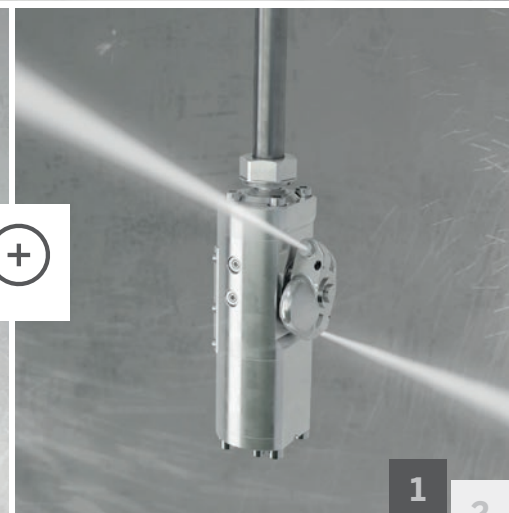

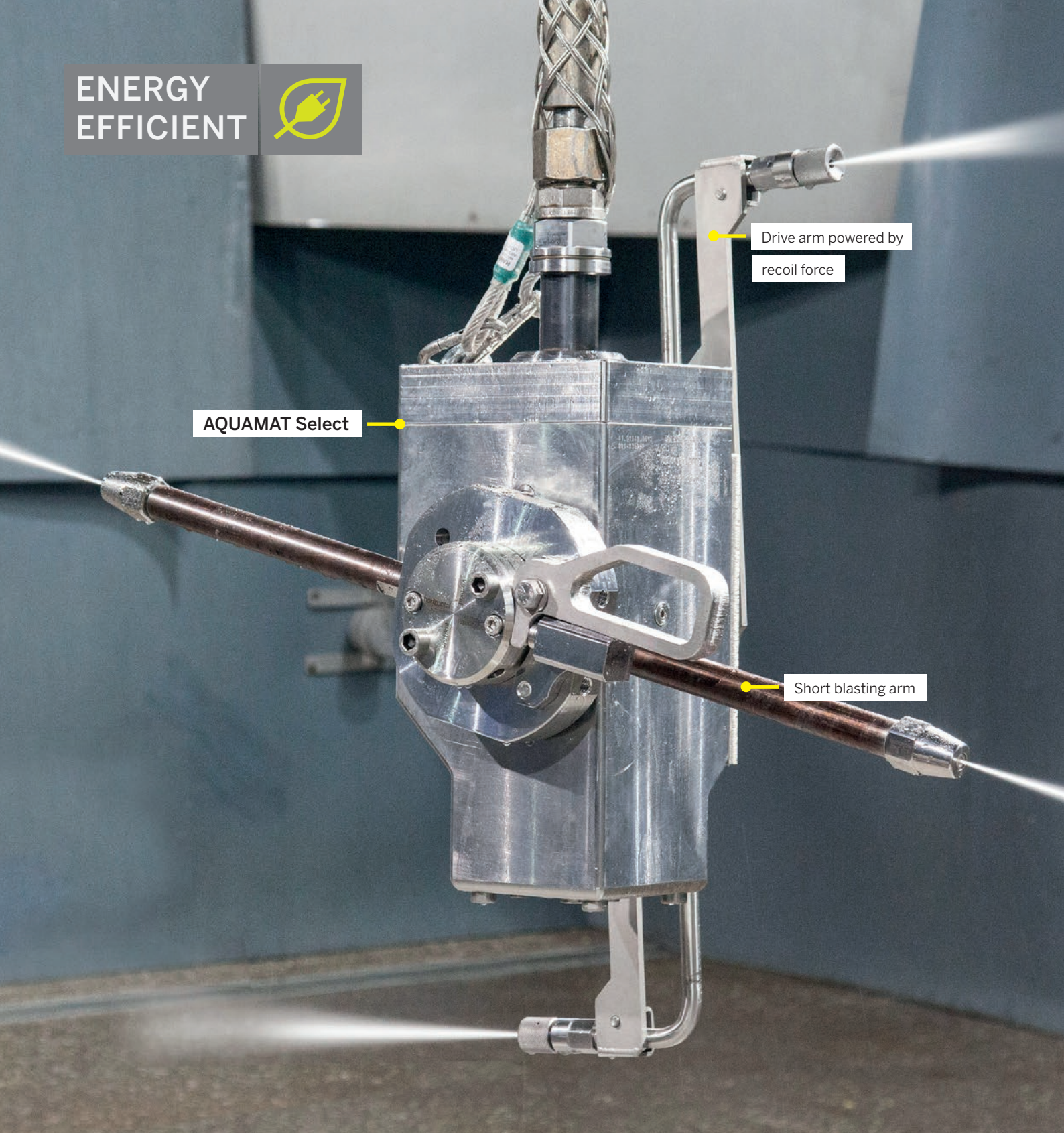

CLEANING OF LARGE CONTAINERS

The cleaning time is reduced by an oscillating movement of the nozzle arms. The oscillation angle can be limited to 35° or 83°. The rotation around the vertical device axis can be preselected to 36° or 81°. When used in large tanks, the tank cleaning device is positioned on the tank wall and offset in sections.

The drive of the AQUAMAT Select is generated by a second, recoil-driven nozzle arm. For its permanent rotation, different nozzle diameters are used depending on the operating pressure. This allows the cleaning time or cleaning performance to be optimized. Further variants for adaptation to the cleaning situation (floor, ceiling) are possible.

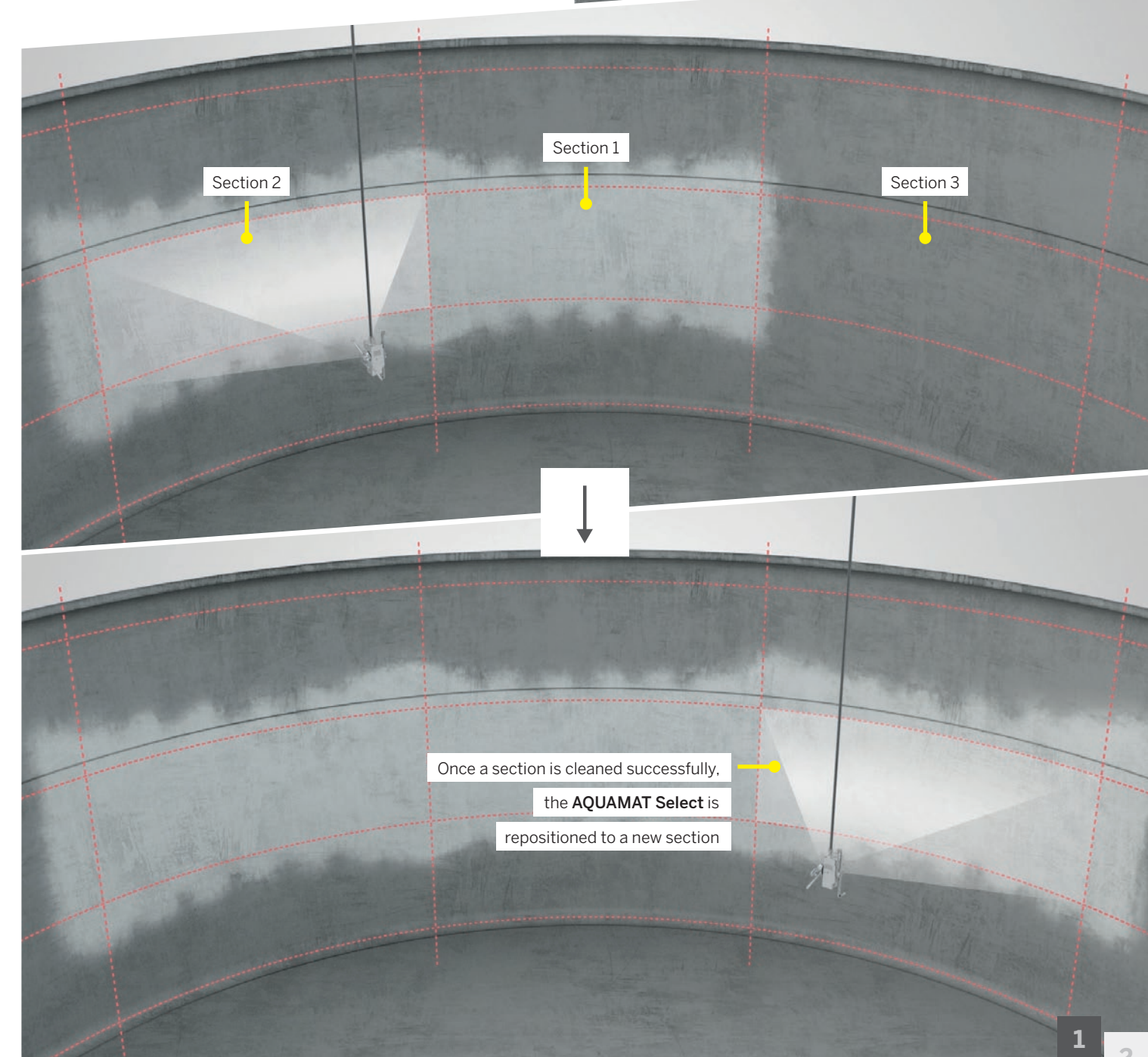
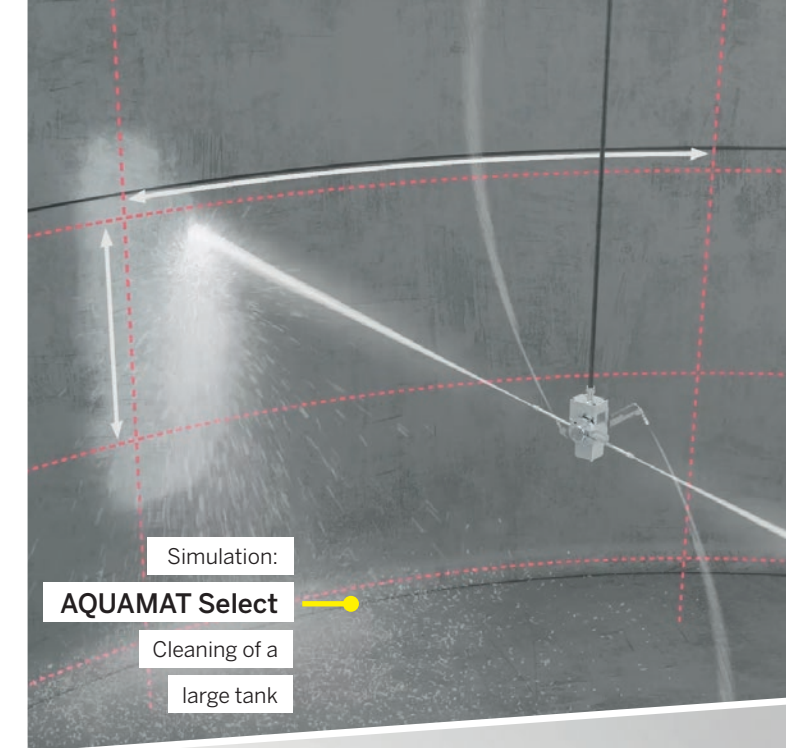

AQUAMAT ACCESSORIES, CONFIGURATION AND CUSTOMIZATION OPTIONS

NOZZLE HOLDERS FOR AQUAMAT TANK CLEANING UNITS

Hammelmann offers nozzle holders in different shapes, lever arms and lance lengths in order to meet the individual requirements of the performance range and cleaning task. Particularly compact designs allow access to smaller cleaning openings.



MANY HIGH-PRESSURE ADAPTERS FOR MANY APPLICATIONS

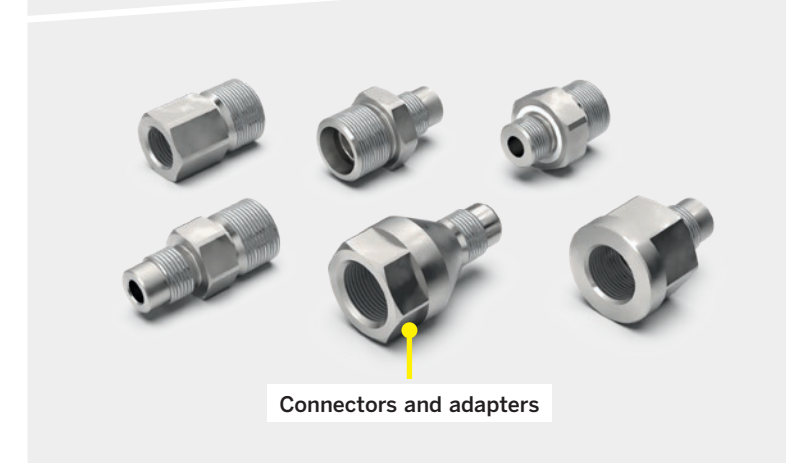

CONVENIENTLY CONFIGURE NOZZLE SET UPS VIA APP

The Hammelmann *Water Jetting Calculator* is a free calculation app for water jet applications. Get an overview of all available nozzle holders and corresponding nozzle inserts and combine them with your AQUAMAT model.



Calculation-App for tank cleaning units

Free app for iOS, Android, Blackberry and your browser

Water Jetting Calculator: hammelmann.com/app

Extension lances
from 4.3 to 43.3 in.



OPTIONS AND ACCESSORIES FOR AQUAMAT TANK CLEANING UNITS

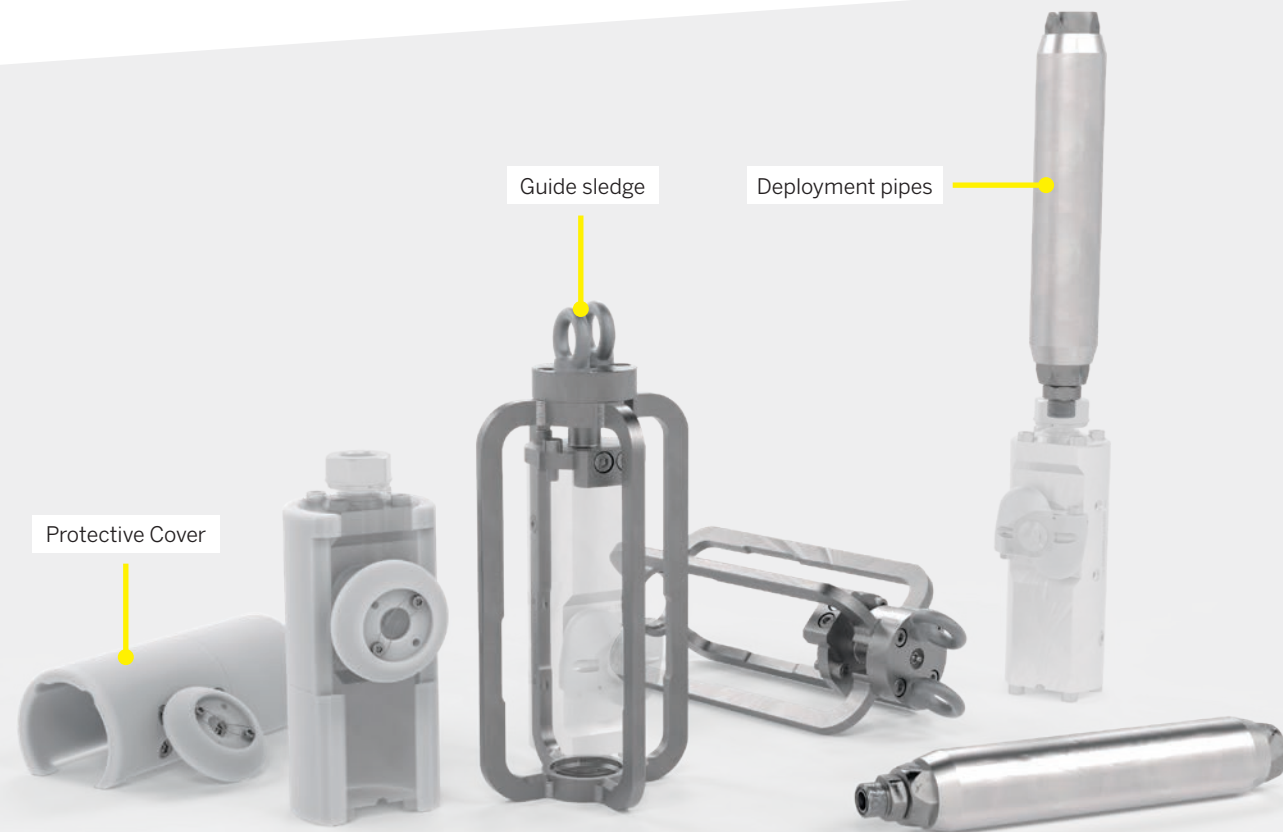

Protective Cover

Guide sledge

Deployment pipes

GUIDE SLEDGE

Guides enable AQUAMAT tank cleaning units to be used for pipe cleaning. The unit is mounted in the centre and a swivelling pulling device is provided. Optional „kick plate“ available so that the assembly self-propels through the pipe.

DEPLOYMENT PIPES

Deployment pipes stabilise the tank cleaning unit. Recommended for use when the unit is freely suspended by the hose with the unit brake adjusted to maximum (max. 1800 bar).

PROTECTIVE COVER

Impact resistant plastic covers for tank cleaning units and nozzle holder arms.



CLEAN PIPES WITH THE AQUAMAT

When combined with a guide sledge, the units can be used for pipe cleaning. They move forward in the pipe automatically thanks to an additional kick plate. Particularly hard deposits and incrustations are removed here.



Pulling device with eyelet

Guide sledge for pipe cleaning with AQUAMAT units

Central positioning of the AQUAMAT in the guide sledge

Optional kick plate for self-propelling forward motion

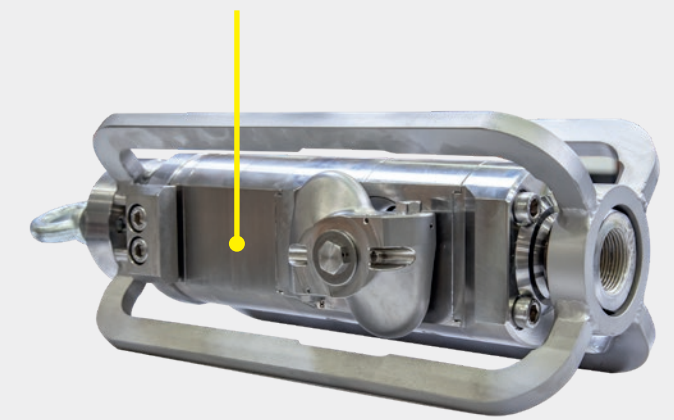

TECHNICAL DETAILS

Model	Nozzle holder type	Operating pressure	Flow rate	Min. pipe Ø
L 1500 Plus	.71 in. S-type, 2 nozzles	up to 21,700 psi	up to 80 gpm.	7.9 in.
XL 1600 Plus	1.37 in. S-type, 2 nozzles	up to 23,200 psi	up to 119 gpm.	12.6 in.
XXL 1600 Plus	0.51 in. S-type, 2 nozzles	up to 23,200 psi	up to 185 gpm.	18.5 in.

2

AQUAREX®
TAILOR-MADE
TANK CLEANING DEVICES

AQUAREX® TAILOR-MADE TANK CLEANING DEVICES

Hammelmann's highly customized tank cleaning devices are tailor-made to perfectly clean the inside of even the most unique tanks and vessels.



HERE ARE A FEW EXAMPLES OF TAILOR-MADE AQUAREX® TANK CLEANING DEVICES



LANCE SYSTEM

With integrated ball valve for permanent installation. The automatic tank cleaning unit remains in the vessel during production.

TELESCOPIC LANCE SYSTEM

The lance is attached onto a manhole. It can be manually rotated, swivelled, retracted and extended. It is pulled out by its own weight.

LANCE HOSE SYSTEM

The lance is positioned over the manhole by the mobile chassis. The lance can be manually rotated, swivelled, retracted and extended.

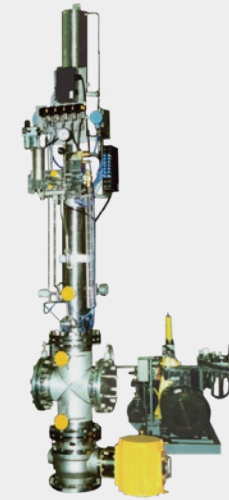

GAS-TIGHT LANCE SYSTEM

Four-stage telescopic lance driven by high pressure water. The cleaning device is controlled and monitored by a freely programmable PLC.



HOSE REEL SYSTEM WITH WEATHERPROOF CABINET

The cleaning positions are freely programmable and controlled by the process plant controller.



GAS-TIGHT HOSE REEL SYSTEM

The system is controlled by PLC with a frequency converter for the reel electric motor.



CLOSE TO UNLIMITED POSSIBILITIES!



AQUAREX® tank cleaning devices are individually developed and manufactured based on your unique requirements. Give us a call or send us an e-mail and we will work with you to find a system that is tailored to meet your challenges!

☎ +49 (0) 25 22 / 76 - 0
✉ mail@hammelmann.de

You can find many other examples online at www.hammelmann.com



HAMMELMANN - DISCOVER THE MARKET LEADER

Hammelmann has been the market-leading supplier of high-pressure pumps and systems for high-pressure applications for over 70 years.

STATE-OF-THE-ART TECHNOLOGY CENTER

For you and for our own R&D we run extensive tests in our modern Technology Center to see how and where water jet technology can be used in an economical, beneficial and ecological way. This is where modern technology and our innovative spirit go hand in hand to test product developments, new ideas, and specific customer requests in a practical setting and to put them through their paces.

Hammelmann attaches greatest importance to the quality of its products and to customer satisfaction. For this reason, products are not only tested under ideal conditions and then sold, but put to the test under extreme conditions.

In order to simulate the toughest and most demanding conditions possible at your site, we have a number of tanks and containers, concrete and metal walls, pipes, lines and components that we prepare and then process accordingly. The extensive tests can be carried out indoors with the help of automated robots and systems, or outdoors.

If desired, simulations can also be developed in cooperation with you. Together we will examine possible solutions for your particular application and provide you with fully documented test protocols and reproducible results. We are looking forward to your challenge.



SPARE PARTS SERVICE IN A CLASS OF ITS OWN, AVAILABLE AROUND THE CLOCK

Hammelmann's unique spare parts service offers you many advantages - a state-of-the-art logistics center, same-day dispatch and short delivery times.



HAMMELMANN

WATER JETTING



SAME DAY DISPATCH

For orders placed by 2 p.m.



18,000 STORAGE SLOTS

For plastic bins



900 SPACES

For Euro-pallets



PARTS & SERVICE

DAYTON / MIAMISBURG

HOUSTON / LA PORTE

☎ 1-800-783-4935
✉ all-dayton@hammelmann.com

☎ 1-866-317-8677
✉ all-houston@hammelmann.com

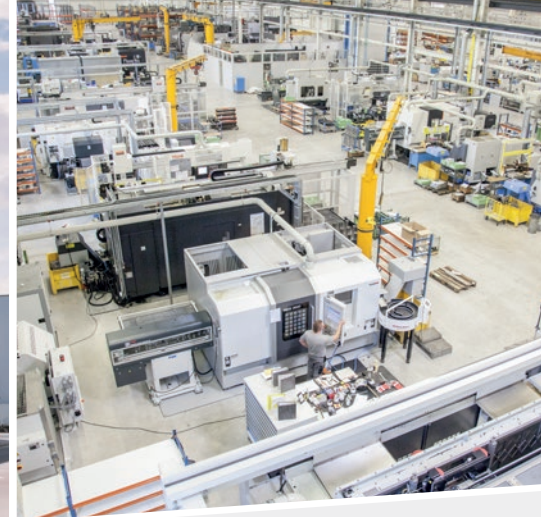

CERTIFICATES

- Achilles Certificate
- ASME Certificate
- SIR Certificate
- ISO 9001:2015
- ISO 14001:2015
- ISO 50001:2011
- TÜV 04 ATEX 2524 X
- BS OHSAS 18001:2007
- ...



The free Hammelmann app

For iOS, Android and your browser

Water Jetting Calculator: hammelmann.com/app

Hammelmann Corporation

436 Southpointe Drive
Miamisburg, OH 45342

☎ 1-800-783-4935

✉ mail@hammelmann.com

🌐 www.hammelmann.us



HAMMELMANN®